

TRIAC(Through Hole / Isolated)

TMG5D60F 5

(Sensitive Gate)

SanRex Triac TMG5D60F 5 is designed for full wave AC control applications. It can be used as an ON/OFF function or for phase control operation.

Typical Applications

- Home Appliances : Washing Machines, Vacuum Cleaners, Rice Cookers, Micro Wave Ovens, Hair Dryers, other control applications
- Industrial Use : SMPS, Copier Machines, Motor Controls, Dimmer, SSR, Heater Controls, Vending Machines, other control applications

Features

- $I_{T(RMS)}=5A$
- High Surge Current
- Low Voltage Drop

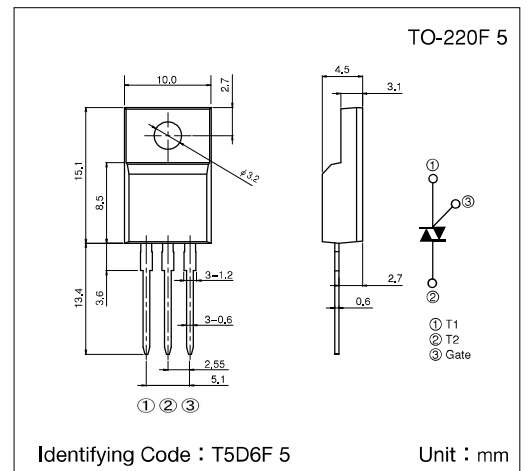

Maximum Ratings

($T_j=25^\circ\text{C}$ unless otherwise specified)

Symbol	Item	Reference	Ratings	Unit
V_{DRM}	Repetitive Peak Off-State Voltage		600	V
$I_{T(RMS)}$	R.M.S. On-State Current	$T_c=100^\circ\text{C}$	5	A
I_{TSM}	Surge On-State Current	One cycle, 50Hz/60Hz, Peak value, non-repetitive	50/55	A
I^2t	I^2t (for fusing)		12.6	A^2s
P_{GM}	Peak Gate Power Dissipation		3	W
$P_{G(AV)}$	Average Gate Power Dissipation		0.3	W
I_{GM}	Peak Gate Current		2	A
V_{GM}	Peak Gate Voltage		10	V
V_{ISO}	Isolation Breakdown Voltage (R.M.S.)	A.C. 1minute	1500	V
T_j	Operating Junction Temperature		$-40 \sim +125$	$^\circ\text{C}$
T_{stg}	Storage Temperature		$-40 \sim +150$	$^\circ\text{C}$
	Mass		2	g

Electrical Characteristics

Symbol	Item	Reference	Ratings			Unit	
			Min.	Typ.	Max.		
I_{DRM}	Repetitive Peak Off-State Current	$V_D=V_{DRM}$, Single phase, half wave, $T_j=125^\circ\text{C}$			1	mA	
V_{TM}	Peak On-State Voltage	$I_T=7A$, Inst. measurement			1.4	V	
I_{GT1}^+	Gate Trigger Current	$V_D=6V$, $R_L=10\Omega$			10	mA	
I_{GT1}^-					10		
I_{GT3}^+					—		
I_{GT3}^-					10		
V_{GT1}^+	Gate Trigger Voltage					1.5	V
V_{GT1}^-						1.5	
V_{GT3}^+						—	
V_{GT3}^-						1.5	
V_{GD}	Non-Trigger Gate Voltage	$T_j=125^\circ\text{C}$, $V_D=1/2V_{DRM}$	0.2			V	
$(dv/dt)_c$	Critical Rate of Rise of Off-State Voltage at Commutation	$T_j=125^\circ\text{C}$, $(di/dt)_c=-2.5A/ms$, $V_D=2/3V_{DRM}$	5			$V/\mu\text{s}$	
I_H	Holding Current			10		mA	
R_{th}	Thermal Resistance	Junction to case			4.0	$^\circ\text{C}/\text{W}$	

Trigger mode of the triac

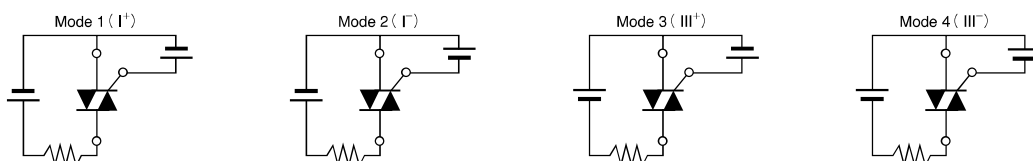

Gate Characteristics

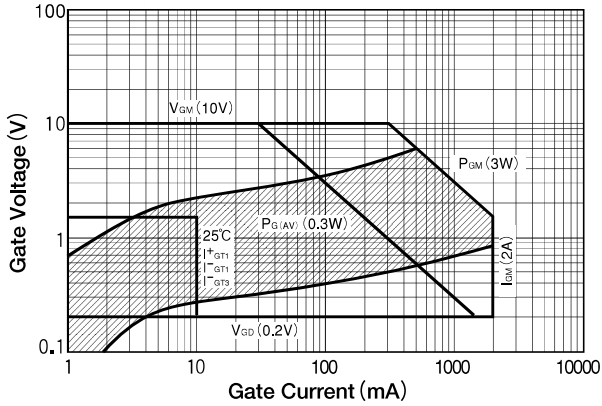

On-State Characteristics (MAX)

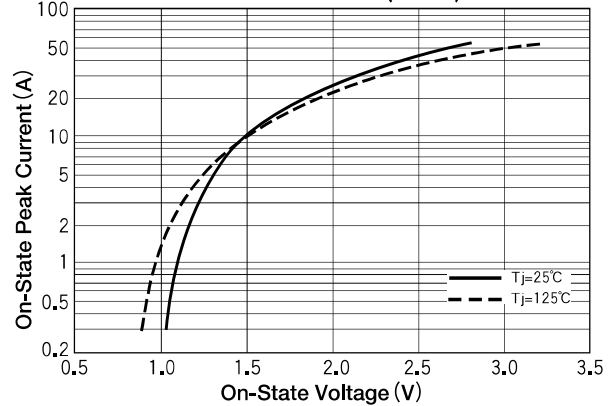

R.M.S. On-State Current vs Maximum Power Dissipation

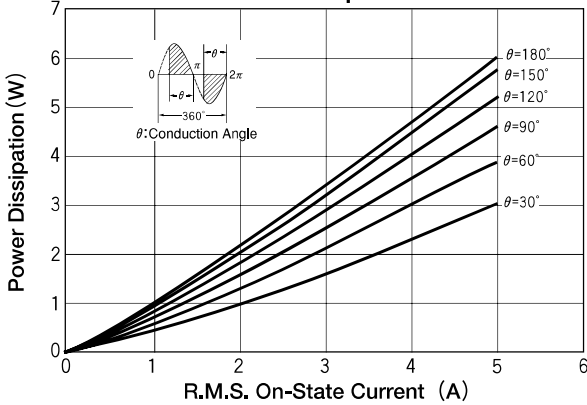

R.M.S. On-State Current vs Allowable Case Temperature

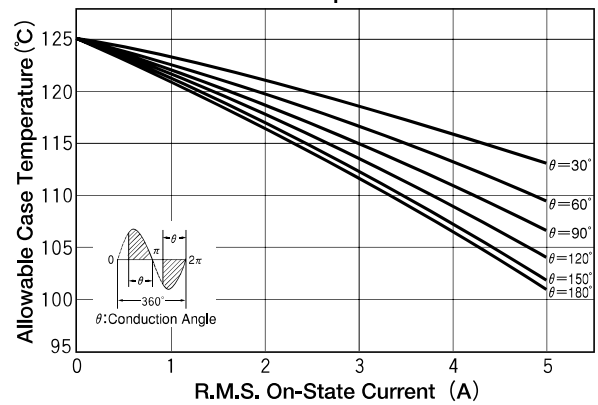

Surge On-State Current Rating (Non-Repetitive)

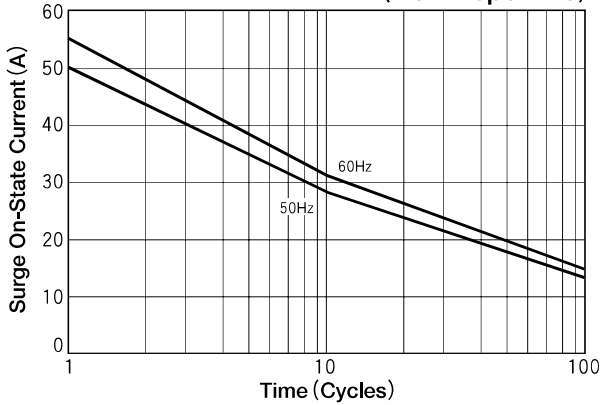

Transient Thermal Impedance

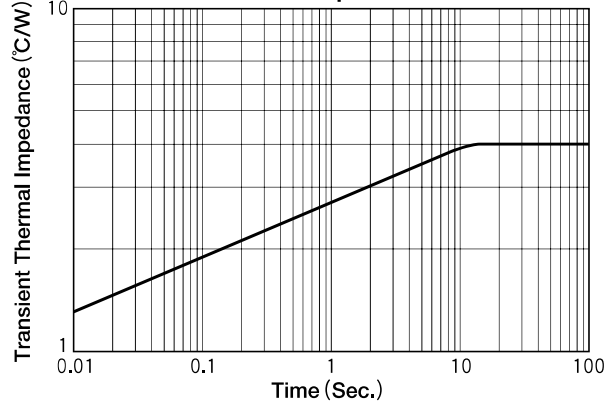

I_GT - Tj (Typical)

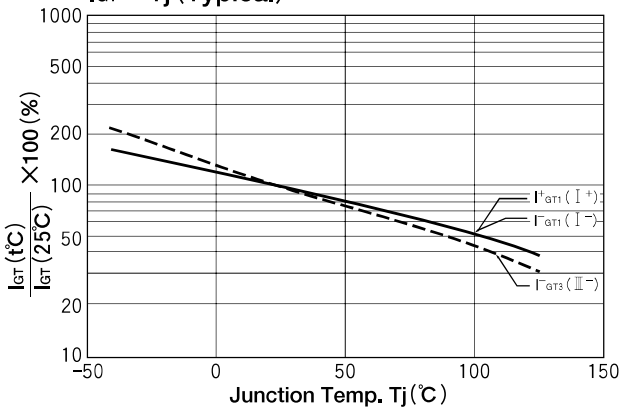

V_GT - Tj (Typical)

