

THYRISTOR(Through Hole/Isolated)

SMG8C60F 5

SanRex Thyristor SMG8C60F 5 is designed for full wave AC control applications. It can be used as an ON/OFF function or for phase control operation.

Typical Applications

- Home Appliances : Electric Blankets, Starter for FL, other control applications
- Industrial Use : SMPS, Solenoid for Breakers, Motor Controls, Heater Controls, other control applications

Features

- $I_{T(AV)}=8A$
- High Surge Current
- Low Voltage Drop

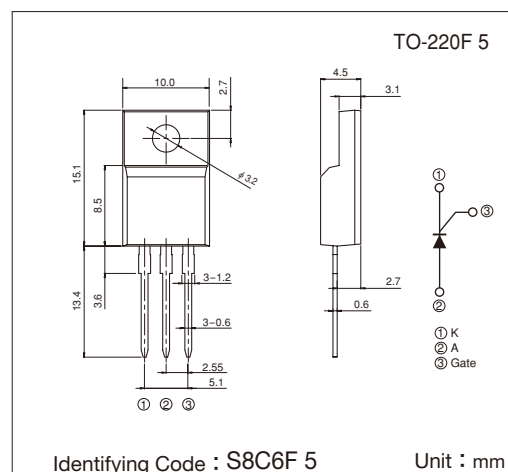

Maximum Ratings

($T_j=25^\circ\text{C}$ unless otherwise specified)

Symbol	Item	Reference	Ratings	Unit
V_{RRM}	Repetitive Peak Reverse Voltage		600	V
V_{RSM}	Non-Repetitive Peak Reverse Voltage		720	V
V_{DRM}	Repetitive Peak Off-State Voltage		600	V
$I_{T(AV)}$	Average On-State Current	Single phase, half wave, 180° , conduction, $T_c=83^\circ\text{C}$	8	A
$I_{T(RMS)}$	R.M.S. On-State Current	Single phase, half wave, 180° , conduction, $T_c=83^\circ\text{C}$	12.6	A
I_{TSM}	Surge On-State Current	50/60Hz, $\frac{1}{2}$ cycle, peak value, non-repetitive	120/130	A
I^2t	I^2t		72	A^2s
P_{GM}	Peak Gate Power Dissipation		5	W
$P_{G(AV)}$	Average Gate Power Dissipation		0.5	W
I_{FGM}	Peak Gate Current		2	A
V_{FGM}	Peak Gate Voltage (Forward)		6	V
V_{RGM}	Peak Gate Voltage (Reverse)		10	V
V_{ISO}	Isolation Breakdown Voltage (R.M.S.)	A.C. 1minute	1500	V
T_j	Operating Junction Temperature		$-40 \sim +125$	$^\circ\text{C}$
T_{stg}	Storage Temperature		$-40 \sim +150$	$^\circ\text{C}$
	Mass		2	g

Electrical Characteristics

($T_j=25^\circ\text{C}$ unless otherwise specified)

Symbol	Item	Reference	Ratings			Unit
			Min.	Typ.	Max.	
I_{DRM}	Repetitive Peak Off-State Current	$T_j=125^\circ\text{C}, V_D=V_{DRM}$			2	mA
I_{RRM}	Repetitive Peak Reverse Current	$T_j=125^\circ\text{C}, V_R=V_{RRM}$			2	mA
V_{TM}	Peak On-State Voltage	$I_T=25A$, Inst. measurement			1.5	V
I_{GT}	Gate Trigger Current	$V_D=6V, R_L=10\Omega$			10	mA
V_{GT}	Gate Trigger Voltage				1.4	V
V_{GD}	Non-Trigger Gate Voltage	$T_j=125^\circ\text{C}, V_D=\frac{1}{2}V_{DRM}$	0.2			V
I_H	Holding Current			15		mA
$R_{th(j-c)}$	Thermal Resistance	Junction to case			3.7	$^\circ\text{C}/W$

Gate Characteristics

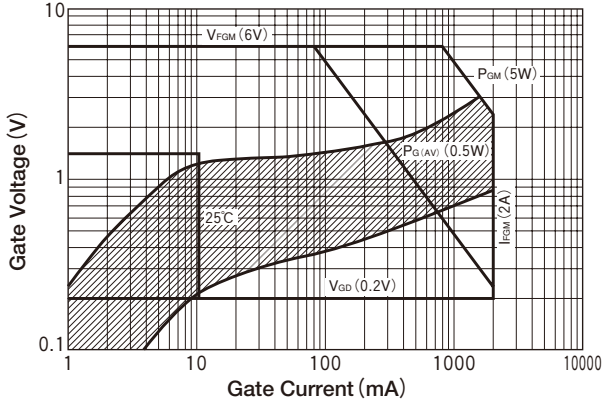

On-State Voltage Max

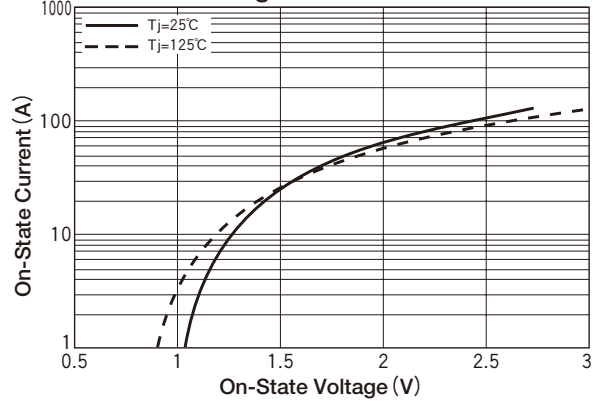

Average On-State Current vs Power Dissipation (Single phase half wave)

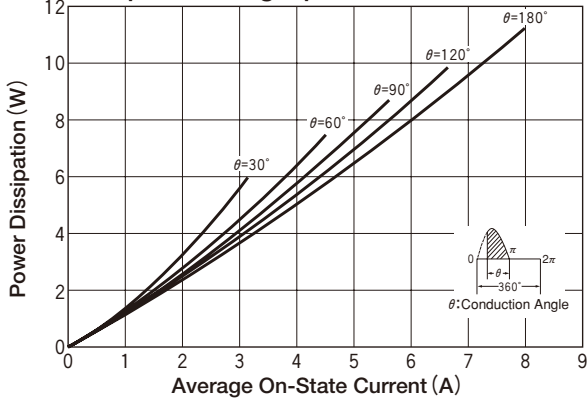

Average On-State Current vs Maximum Allowable Case Temperature (Single phase half wave)

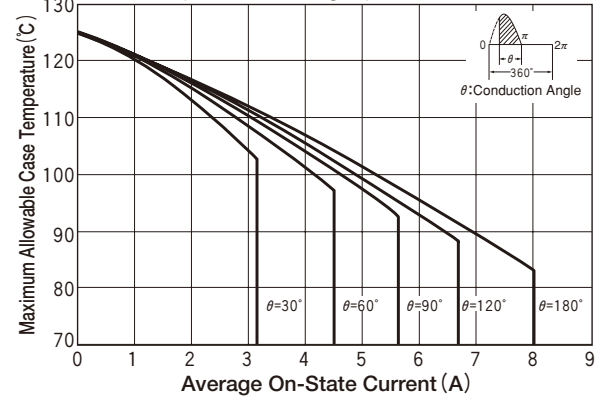

Surge On-State Current Rating (Non-Repetitive)

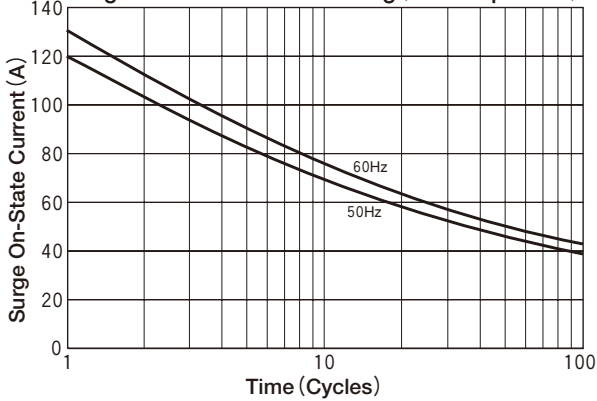

Maximum Transient Thermal Impedance Characteristics

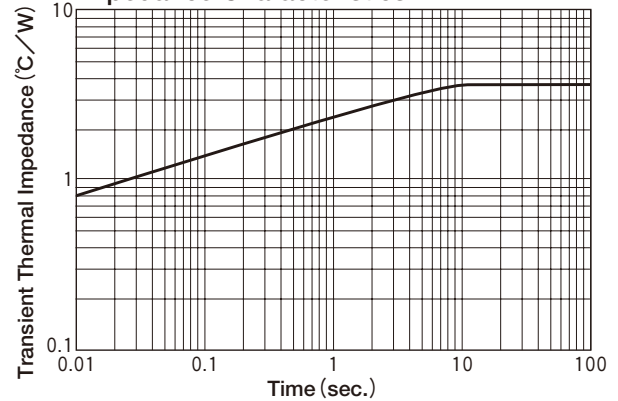

I_GT - Tj [Change Rate] (Typical)

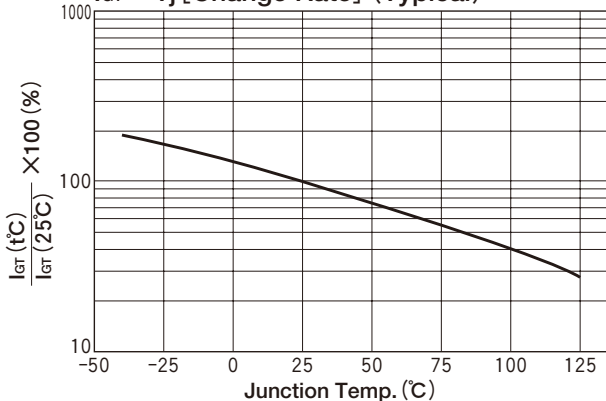

V_GT - Tj (Typical)

